

General Description

This demonstration board utilizes the AL9910 high voltage PWM LED driver-controller providing a cost effective solution for offline high brightness LED applications that do not require triac dimming. This user-friendly evaluation board provides users with quick connection to their different types LEDs string. The demonstration board can be modified to adjust the LED output current and the number of series connected LEDs that are driven.

A bill of materials is included that describes the parts used on this demonstration board. A schematic and layout have also been included along with measured performance characteristics. These materials can be used as a reference design for your products improving your product's time to market.

Key Features

- Selectable 2W-6W output power
- Active PFC with power factor >0.9
- No electrolytic capacitor or selection for low output ripple

Applications

- Retrofit E12, E27, PAR3x bulb applications

Specifications

Parameter	Value
AC Input Voltage	90V – 140V
Output Power	2W – 6W
LED Current	130mA
LED Voltage	30V
Efficiency	> 85%
Power Factor	>0.9
Output Ripple	<45% (p-p)
XY Dimension	1.155" x 0.590"
ROHS Compliance	Yes

Top-View Evaluation Board

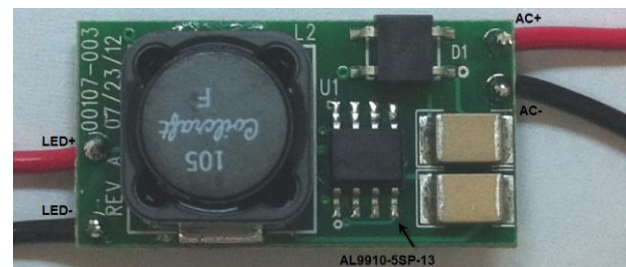

Bottom-View Evaluation Board

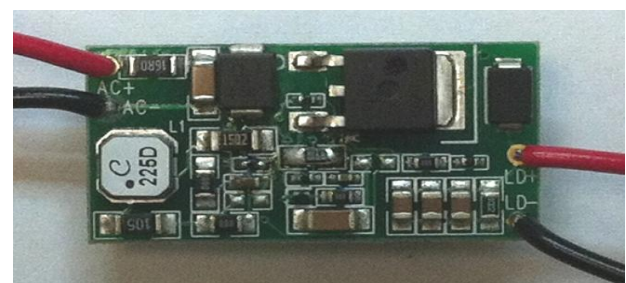

Connection Instructions:

- AC+ Input: Red – Hot
- AC- Input: Black – Neutral
- DC LED+ Output: LD+ (Red)
- DC LED- Output: LD- (Black)

Board Layout

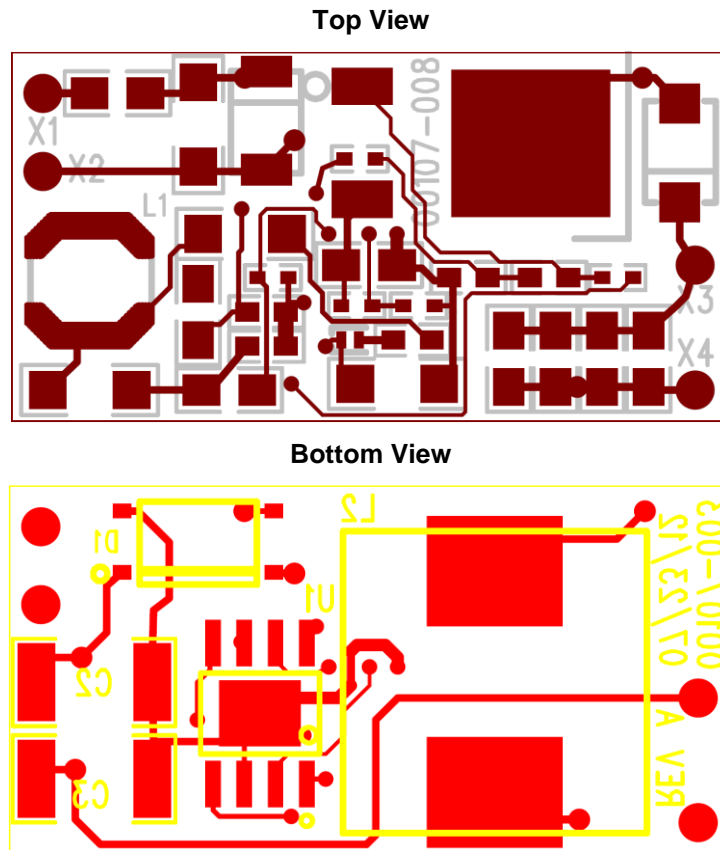

Evaluation Board Connection Setup and Power-up Procedure

1. Preset the isolated AC source to 120V_{AC}.
2. Ensure that the AC source is switched OFF or disconnected.
3. Connect the anode wire of the LED string to the LD+ of the evaluation board.
4. Connect the cathode wire of the LED string to the LD - terminal of the evaluation board.
5. Connect two AC line wires to the AC+ and AC- terminals on the evaluation board.
6. Ensure that the area around the board is clear and safe, and preferably that the board and LEDs are enclosed in a transparent safety cover.
7. Turn on the main switch. LED string should light up with LED.
DO NOT TOUCH THE BOARD, LEDs OR BARE WIRING.

Caution: The AL9910EV10.120 is a non-isolated design. All terminals carry high voltage during operation!

Schematic

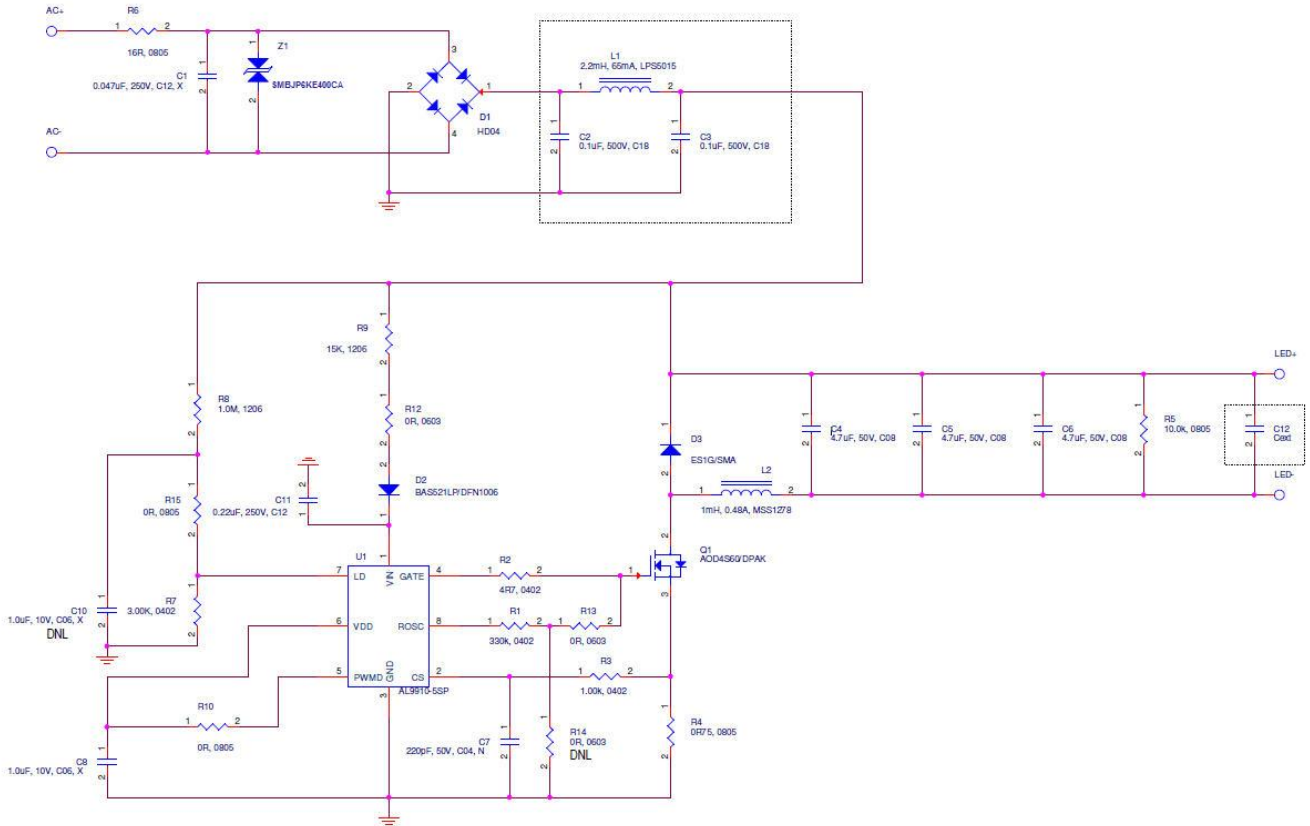

Bill of Material

#	Name	Quantity	Part number	Manufacturer	Description
1	U1	1	AL9910-5SP-13	Diodes Inc	Universal High Voltage LED Driver in SO-8EP package
2	D1	1	HD04-T	Diodes Inc	RECT BRIDGE GP 400V 0.8A MINIDIP
3	D2	1	BAS521	Diodes Inc	High Voltage Switching Diode 300V
4	D3	1	ES1G-13-F	Diodes Inc	DIODE SUPER FAST 1A 400V SMA
5	Q1	1	AOD4S60	Alpha Omega	MOSFET N-CH 600V 4A DPAK
6	Z1	1	P6KE400CA	Littelfuse Inc	TVS Bidirectional Diode 600W 400V
7	C1	1	C3216X7R2E473K	TDK	Multilayer Ceramic Capacitor (1206) 0.047 μ F 250V 10%
8	C2, C3	2	VJ1812Y104KXETW1BC	Vishay	CAP Multilayer Cer (MLCC) - SMD/SMT 1812 0.1 μ F 500volts X7R 10%
9	C4, C5, C6	3	C2012X5R1H475K	TDK	Multilayer Ceramic Capacitors (0805) 4.7 μ F 50V 10%
10	C7	1	GRM15571H221JA01J	Murata	Multilayer Ceramic Capacitors (0402) 220pF 50V 50%
11	C8	1	C1608X7R1A105K	TDK	CAP CER 1.0 μ F 10V X7R 0603
12	C11	1	C3216X7T2E224K	TDK	Multilayer Ceramic Capacitors (1206) 0.22 μ F 250V 10%
13	R1	1	CRCW0402330KFCTD	Vishay	RES 330K Ω 1/16W 1% 0402 SMD
14	R2	1	CRCW04024R70FKED	Vishay	RES 4.7 Ω 1/16W 1% 0402 SMD
15	R3	1	CRCW04021K00FKED	Vishay	RES 1.0K Ω 1/16W 1% 0402 SMD
16	R4	1	RL0805FR-070R75L	Vishay	RES 0.75 Ω 1/8W 1% 0805 SMD
17	R5	1	ERJ-6ENF1002V	Panasonic-ECG	RES 10K Ω 1/8W 1% 0805 SMD
18	R6	1	CRCW120616R0FKEA	Vishay	RES 16.0 Ω 1/4W 1% 1206 SMD
19	R7	1	RC0402FR-073K01L	Yageo	RES 3.01K Ω 1/16W 1% 0402 SMD
20	R8	1	CRCW12061M00JNEA	Vishay	RES 1M Ω 1/4W 5% 1206 SMD
21	R9	1	ESR18EZPJ153	Rohm Semiconductor	RES 15K Ω 1/3W 5% 1206 SMD
22	R10	2	CRCW08050000Z0EA	Vishay	RES 0.0 Ω 1/8W 1% 0805 SMD
23	R12, R13, R15	3	CRCW06030000Z0EA	Vishay	RES 0.0 Ω 1/8W 1% 0603 SMD
24	L1	1	LPS5015-225ML	Coilcraft	2.2mH 64mA
25	L2	1	MSS1278T-105KLB	Coilcraft	IND Power 1mH SMT (12.5x12.5x8)
26	C12	1	ECA-1HHG221	Panasonic	EXT CAP ALUM 220 μ F 50V 20% Radial

Functional Performance

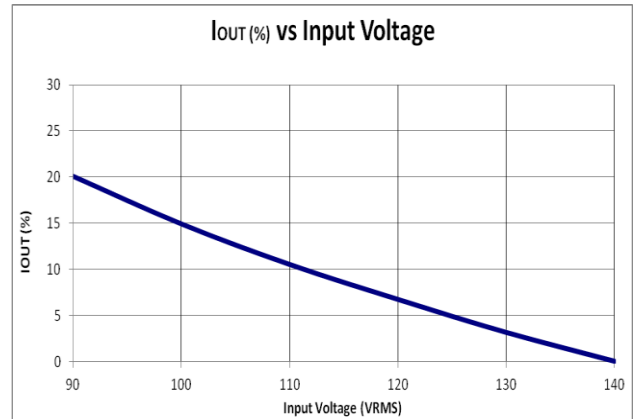
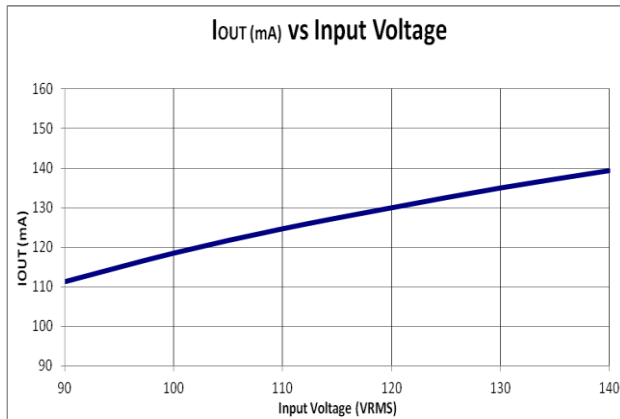
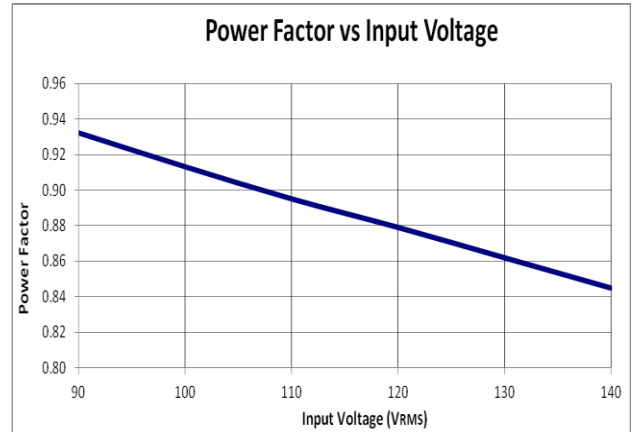
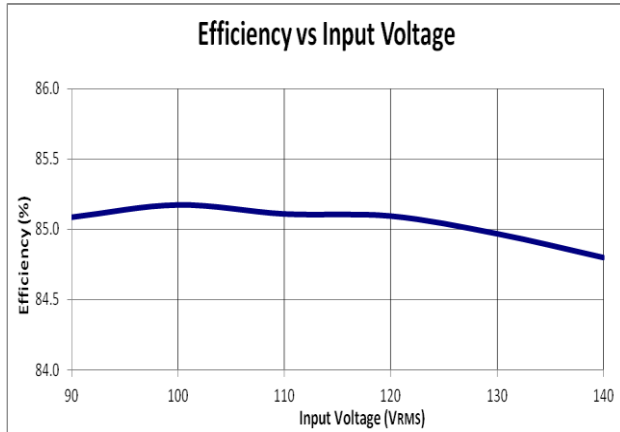

Functional Waveforms (with output E-Capacitor for Low Output Ripple)

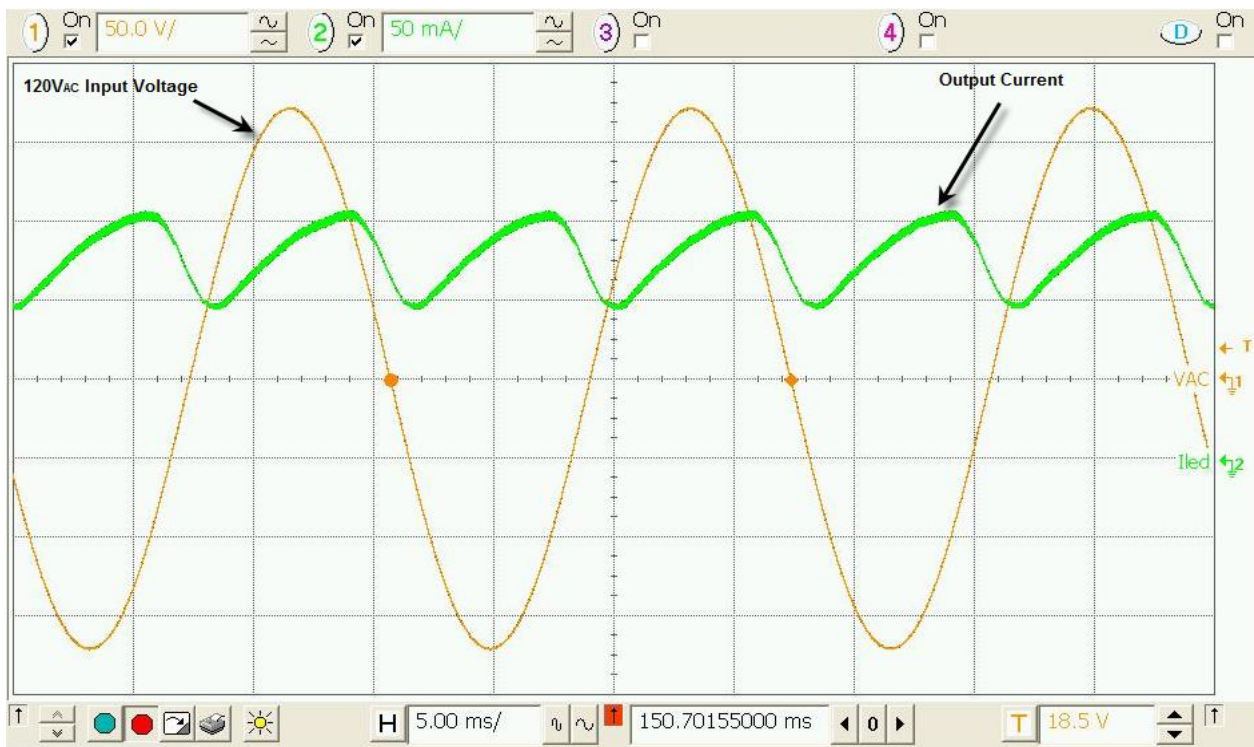
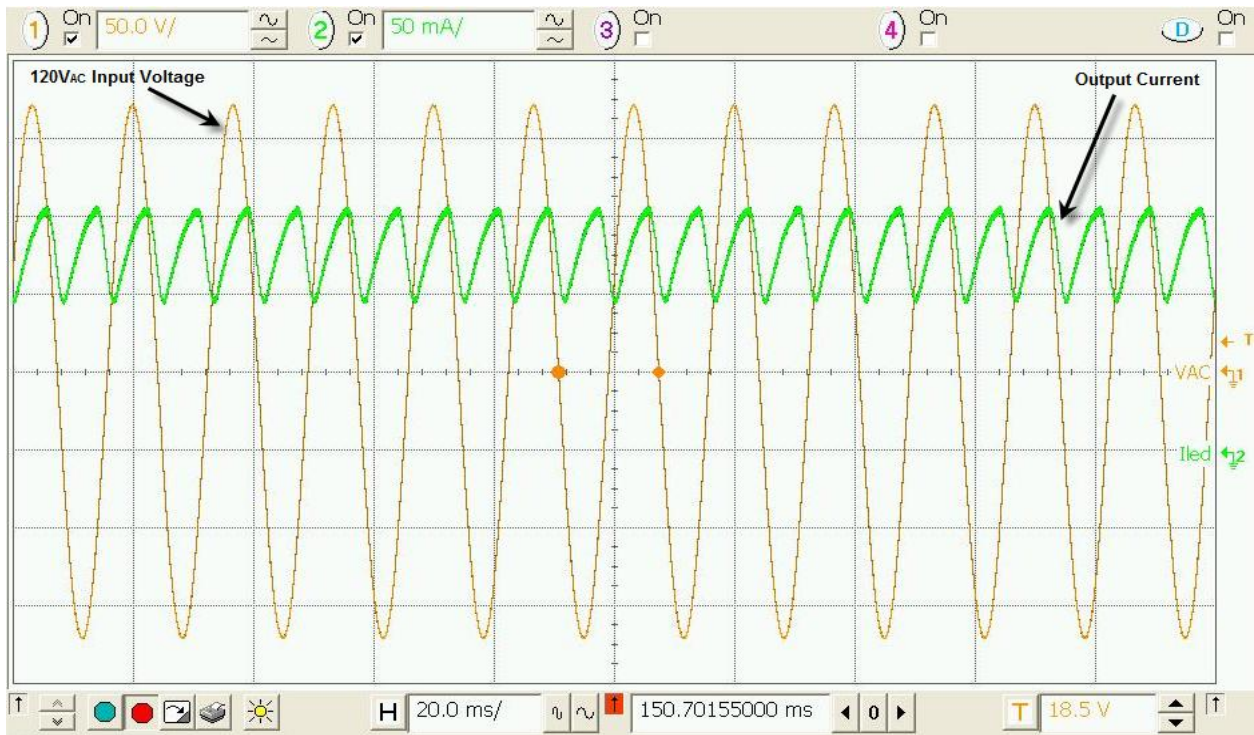

IMPORTANT NOTICE

DIODES INCORPORATED MAKES NO WARRANTY OF ANY KIND, EXPRESS OR IMPLIED, WITH REGARDS TO THIS DOCUMENT, INCLUDING, BUT NOT LIMITED TO, THE IMPLIED WARRANTIES OF MERCHANTABILITY AND FITNESS FOR A PARTICULAR PURPOSE (AND THEIR EQUIVALENTS UNDER THE LAWS OF ANY JURISDICTION).

Diodes Incorporated and its subsidiaries reserve the right to make modifications, enhancements, improvements, corrections or other changes without further notice to this document and any product described herein. Diodes Incorporated does not assume any liability arising out of the application or use of this document or any product described herein; neither does Diodes Incorporated convey any license under its patent or trademark rights, nor the rights of others. Any Customer or user of this document or products described herein in such applications shall assume all risks of such use and will agree to hold Diodes Incorporated and all the companies whose products are represented on Diodes Incorporated website, harmless against all damages.

Diodes Incorporated does not warrant or accept any liability whatsoever in respect of any products purchased through unauthorized sales channel.

Should Customers purchase or use Diodes Incorporated products for any unintended or unauthorized application, Customers shall indemnify and hold Diodes Incorporated and its representatives harmless against all claims, damages, expenses, and attorney fees arising out of, directly or indirectly, any claim of personal injury or death associated with such unintended or unauthorized application.

Products described herein may be covered by one or more United States, international or foreign patents pending. Product names and markings noted herein may also be covered by one or more United States, international or foreign trademarks.

LIFE SUPPORT

Diodes Incorporated products are specifically not authorized for use as critical components in life support devices or systems without the express written approval of the Chief Executive Officer of Diodes Incorporated. As used herein:

- A. Life support devices or systems are devices or systems which:
 - 1. are intended to implant into the body, or
 - 2. support or sustain life and whose failure to perform when properly used in accordance with instructions for use provided in the labeling can be reasonably expected to result in significant injury to the user.
- B. A critical component is any component in a life support device or system whose failure to perform can be reasonably expected to cause the failure of the life support device or to affect its safety or effectiveness.

Customers represent that they have all necessary expertise in the safety and regulatory ramifications of their life support devices or systems, and acknowledge and agree that they are solely responsible for all legal, regulatory and safety-related requirements concerning their products and any use of Diodes Incorporated products in such safety-critical, life support devices or systems, notwithstanding any devices- or systems-related information or support that may be provided by Diodes Incorporated. Further, Customers must fully indemnify Diodes Incorporated and its representatives against any damages arising out of the use of Diodes Incorporated products in such safety-critical, life support devices or systems.

Copyright © 2012, Diodes Incorporated

www.diodes.com