

Description

The AP2303 is a low dropout linear regulator to generate termination voltage of DDR-SDRAM system. The regulator can source or sink up to 1.75A current continuously. The output voltage is regulated to track tightly with the reference voltage ($1/2V_{DDQ}$) within $\pm 10mV$.

The AP2303 supports soft start-up when used to turn on the VCNTL and VREFEN. It integrates a shutdown circuit that will be triggered once the voltage of VIN, VCNTL or VREFEN falls below a certain value.

The AP2303 features over temperature protection and current limit protection for both source and sink.

The AP2303 is available in packages of SOIC-8 and PSOP-8.

Features

- Support DDR-II ($V_{TT} = 0.9V$), DDR-III ($V_{TT} = 0.75V$), DDR-IIIIL ($V_{TT} = 0.675V$), DDR-IV ($V_{TT} = 0.6V$) Application
- Source and Sink up to 1.75A Current
- Output Voltage Accuracy Over Full Load: $\pm 2\%$ (max.)
- Soft Start-up and Shutdown along with VIN, VCNTL and VREFEN Rising and Shutdown along with VIN, VCNTL and VREFEN Dropping
- Flexible Output by 2 External Resistors
- Requires minimum 10 μ F Output Ceramic Capacitor for Application
- Current Limit Protection for Both Source and Sink
- OTSD Protection
- **Totally Lead-Free & Fully RoHS Compliant (Notes 1 & 2)**
- **Halogen and Antimony Free. "Green" Device (Note 3)**
- **For automotive applications requiring specific change control (i.e. parts qualified to AEC-Q100/101/104/200, PPAP capable, and manufactured in IATF 16949 certified facilities), please [contact us](https://www.diodes.com/quality/product-definitions/) or your local Diodes representative.**
<https://www.diodes.com/quality/product-definitions/>

- Notes:
1. No purposely added lead. Fully EU Directive 2002/95/EC (RoHS), 2011/65/EU (RoHS 2) & 2015/863/EU (RoHS 3) compliant.
 2. See <https://www.diodes.com/quality/lead-free/> for more information about Diodes Incorporated's definitions of Halogen- and Antimony-free, "Green" and Lead-free.
 3. Halogen- and Antimony-free "Green" products are defined as those which contain <900ppm bromine, <900ppm chlorine (<1500ppm total Br + Cl) and <1000ppm antimony compounds.

Pin Assignments

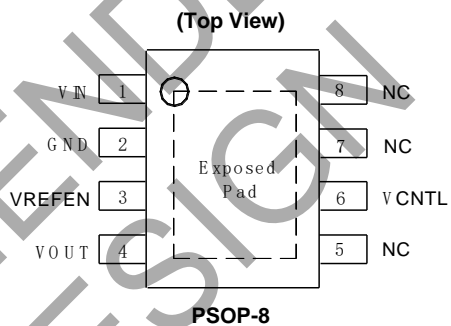
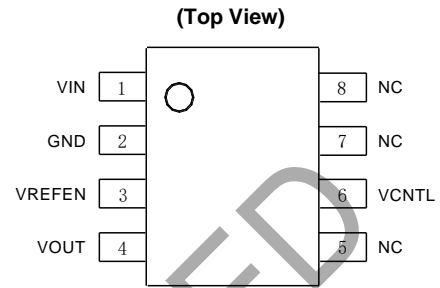

Applications

- DDR-II/DDR-III/DDR-IIIIL/DDR-IV memory systems
- Desktop PCs, notebook mother boards
- Graphic cards
- STB, LCD-TV, Web-TV

Typical Applications Circuit

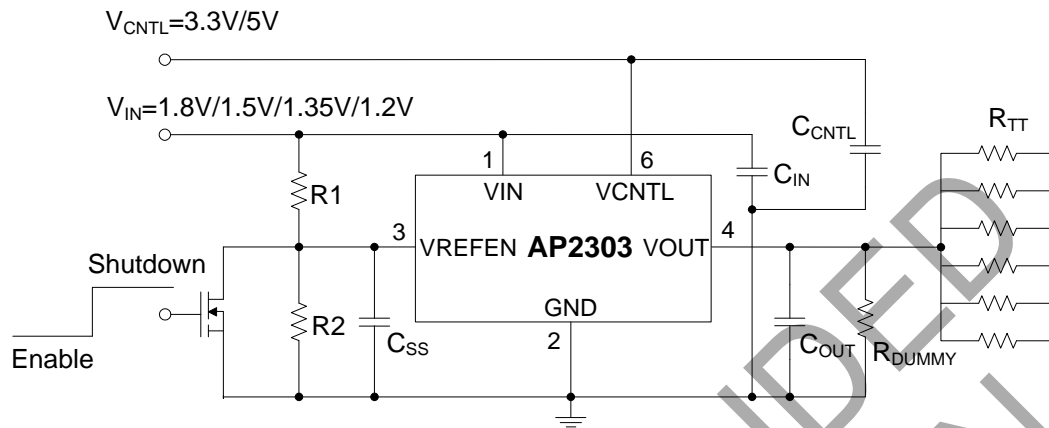

Pin Descriptions

Pin Number	Pin Name	Function
1	VIN	Unregulated input supply. A small 10µF MLCC should be connected from this pin to GND.
2	GND	Ground
3	VREFEN	Reference voltage input and active low shutdown control pin. Pulling the pin to ground turns off device by BJT or FET. When it is released, a soft-start will take for about 0.1ms.
4	VOUT	Regulated voltage output. A minimum of 10µF ceramic capacitor to ground is required to assure stability.
5, 7, 8	NC	No Connection
6	VCNTL	VCNTL supplies the internal control circuitry and provides the drive voltage.
—	Exposed Pad	The exposed pad should be connected to ground copper for better heat dissipation performance.

Functional Block Diagram

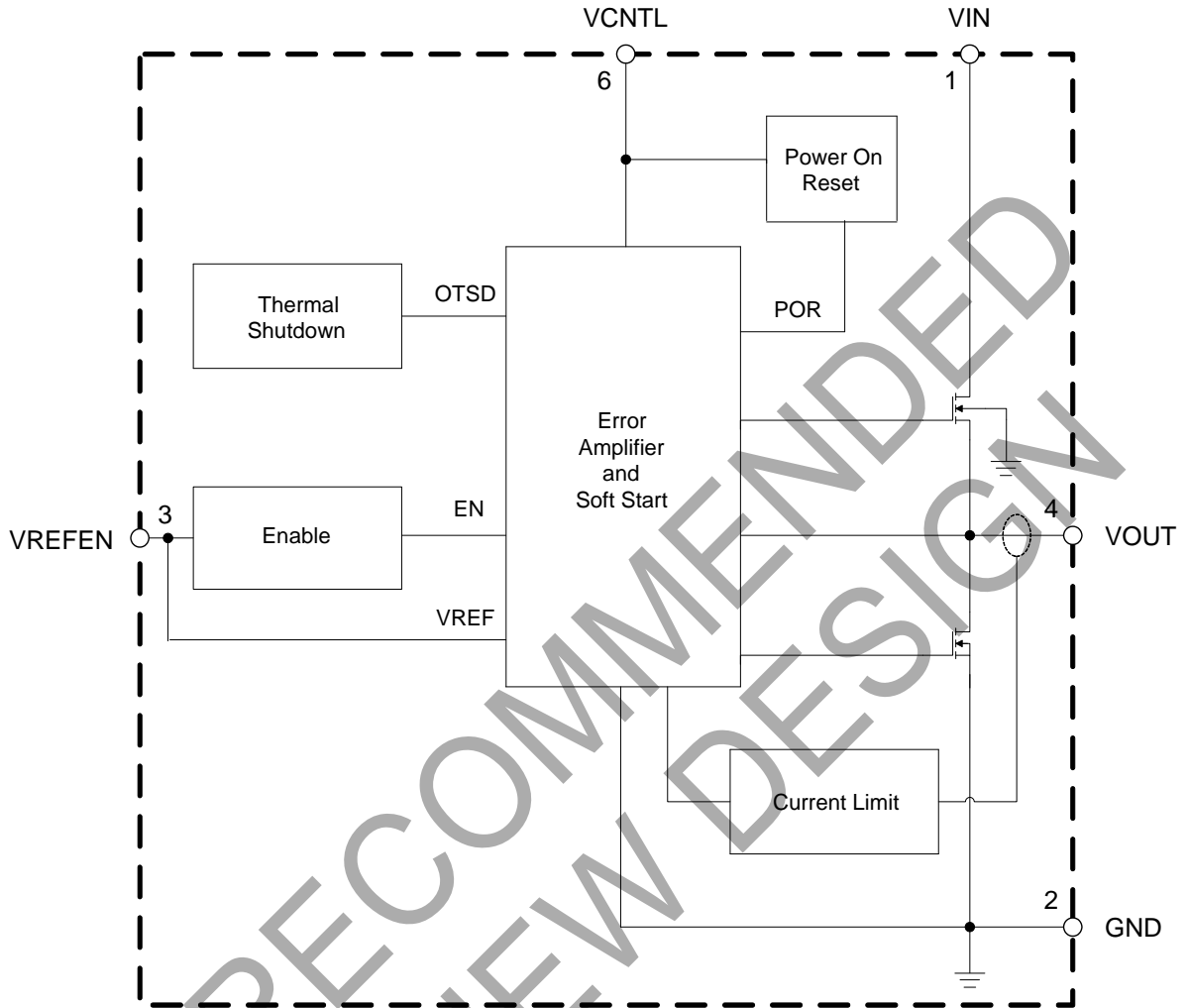

NOT RECOMMENDED FOR NEW DESIGN

Absolute Maximum Ratings (Note 4)

Symbol	Parameter	Rating	Unit	
V_{IN}	Power Input Voltage	-0.3 to 6	V	
V_{CNTL}	Control Input Voltage	-0.3 to 6	V	
V_{REFEN}	Reference Input Voltage	-0.3 to 6	V	
T_{STG}	Storage Temperature	+150	°C	
T_J	Junction Temperature	+150	°C	
T_{LEAD}	Lead Temperature (Soldering, 10sec)	+260	°C	
θ_{JA}	Thermal Resistance (Junction to Ambient) (Note 5)	PSOP-8	80	°C/W
		SOIC-8	110	
θ_{JC}	Thermal Resistance (Junction to Case)	PSOP-8	38	°C/W
		SOIC-8	50	
ESD	ESD (Human Body Model)	2000	V	
ESD	ESD (Machine Model)	200	V	

- Notes:
- Stresses greater than those listed under "Absolute Maximum Ratings" can cause permanent damage to the device. These are stress ratings only, and functional operation of the device at these or any other conditions beyond those indicated under "Recommended Operating Conditions" is not implied. Exposure to "Absolute Maximum Ratings" for extended periods can affect device reliability.
 - θ_{JA} is measured with the component mounted on a 2-Layer FR-4 board with 2.54cm*2.54cm thermal sink pad in free air.

Recommended Operating Conditions

Symbol	Parameter	Min	Max	Unit
V_{CNTL}	Control Input Voltage (Note 6)	3.0	5.5	V
V_{IN}	Power Input Voltage	1.2	5.5	V
V_{REFEN}	Reference Input Voltage	0.6	$V_{CNTL}-2.2$	V
T_J	Operating Junction Temperature Range	-40	+125	°C
T_A	Operating Ambient Temperature Range	-40	+85	°C

- Note:
- Keep $V_{CNTL} \geq V_{IN}$ in operation power on and power off sequences.

Electrical Characteristics (@ $T_A = +25^\circ\text{C}$, $V_{IN} = 1.8\text{V}/1.5\text{V}/1.35\text{V}/1.2\text{V}$, $V_{CNTL} = 3.3\text{V}$, $V_{REFEN} = 0.9\text{V}/0.75\text{V}/0.675\text{V}/0.6\text{V}$, $C_{IN} = 10\mu\text{F}$ (Ceramic), $C_{OUT} = 10\mu\text{F}$ (Ceramic), unless otherwise specified.)

Symbol	Parameter	Conditions	Min	Typ	Max	Unit
Input						
I_{VCNTL}	VCNTL Operating Current	No Load	—	0.5	1.5	mA
$I_{SD-VCNTL}$	VCNTL Input Current in Shutdown Mode	$V_{REFEN} < 0.15\text{V}$	—	30	50	μA
I_{SD-VIN}	VIN Input Current in Shutdown Mode	$V_{REFEN} < 0.15\text{V}$	-1	—	1	μA
I_{VREFEN}	VREFEN Leakage Current	$V_{REFEN} = 0.75\text{V}$	-1	—	1	μA
Output						
V_{OS}	Output Offset Voltage (Note 7)	No Load	-10	0	10	mV
$V_{DROPOUT}$	Dropout Voltage	$V_{CNTL} = 3.3\text{V}$, $I_{OUT} = 1\text{A}$	—	220	—	mV
		$V_{CNTL} = 3.3\text{V}$, $I_{OUT} = 1.5\text{A}$	—	400	—	
		$V_{CNTL} = 3.3\text{V}$, $I_{OUT} = 1.75\text{A}$	—	520	—	
V_{LOAD}	Load Regulation	$I_{OUT} = 0\text{A to } 1.75\text{A}$	-20	—	20	mV
		$I_{OUT} = 0\text{A to } -1.75\text{A}$	-20	—	20	
Protection						
I_{LIMIT}	Current Limit	Source	1.75	—	—	A
		Sink	—	—	-1.75	
I_{SHORT}	Short Current	$V_{OUT} = 0\text{V}$	—	2	—	A
		$V_{OUT} = V_{IN}$	—	-2	—	
T_{SHDN}	Thermal Shutdown Temperature	$3.3\text{V} \leq V_{CNTL} \leq 5\text{V}$	—	+160	—	$^\circ\text{C}$
—	Thermal Shutdown Hysteresis	—	—	+30	—	$^\circ\text{C}$
Start-up & Shutdown Function						
V_{IH}	VREFEN Shutdown Threshold Voltage	Output = High	0.4	—	—	V
V_{IL}		Output = Low	—	—	0.15	
$V_{CNTL-ON}$	VCNTL Shutdown Threshold Voltage	Output = High	2.9	—	—	V
$V_{CNTL-OFF}$		Output = Low	—	—	2.2	
V_{IN-ON}	VIN Shutdown Threshold Voltage	Output = High	1.1	—	—	V
V_{IN-OFF}		Output = Low	—	—	0.4	

Note: 7. V_{OS} is the voltage measurement defined as V_{OUT} subtracted from V_{REFEN} .

Performance Characteristics

Output Offset Voltage vs. Ambient Temperature

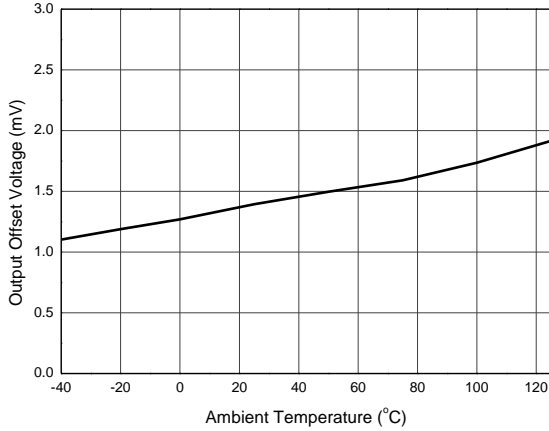

Dropout Voltage vs. Output Current

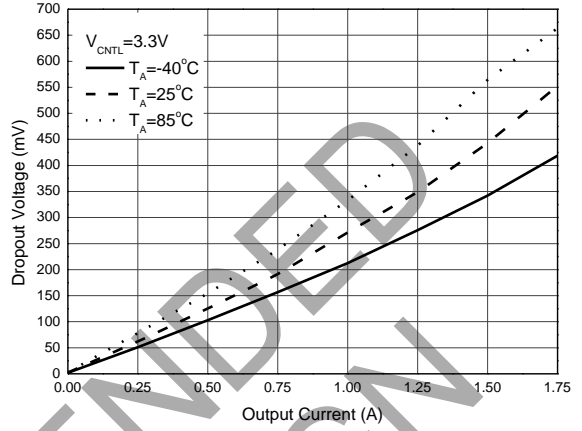

Source Current Limit vs. VCNTL Input Voltage

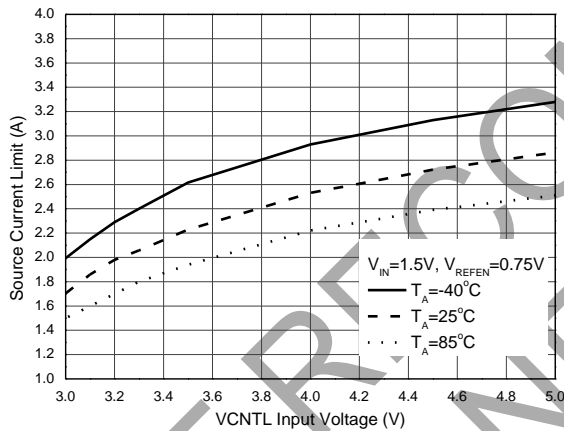

Sink Current Limit vs. VCNTL Input Voltage

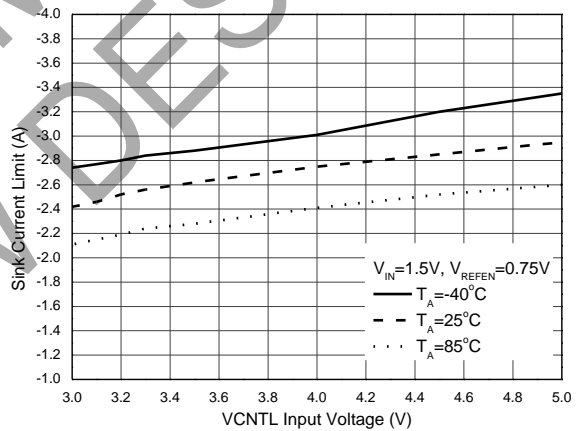

VCNTL Operating Input Current vs. Ambient Temperature

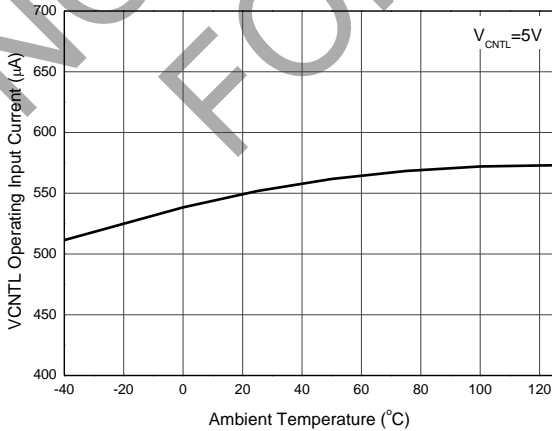

VCNTL Standby Current vs. Ambient Temperature

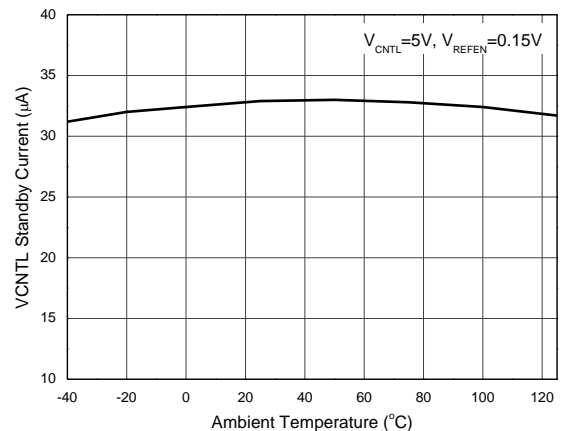

Performance Characteristics (continued)

Output Voltage vs. Source Current (DDR-III)

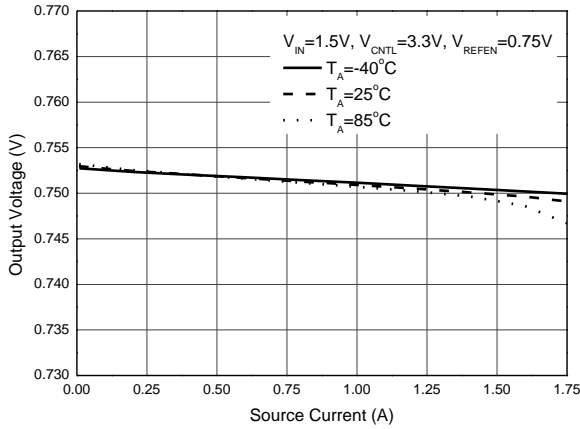

Output Voltage vs. Sink Current (DDR-III)

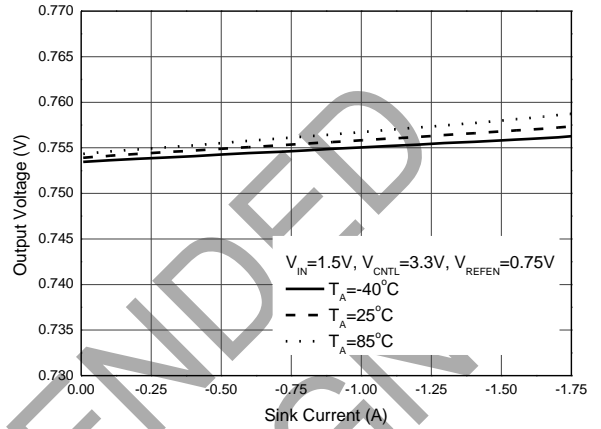

Output Voltage vs. Source Current (DDR-IV)

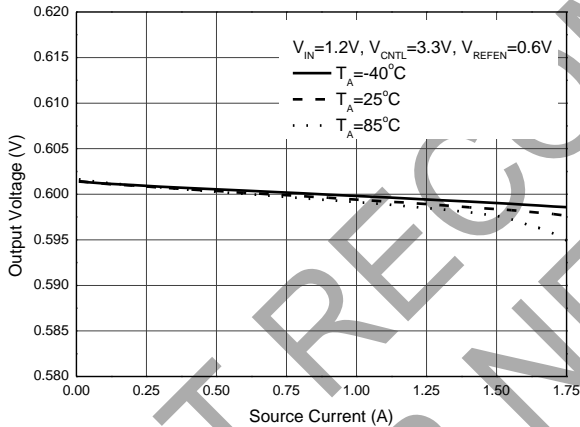

Output Voltage vs. Sink Current (DDR-IV)

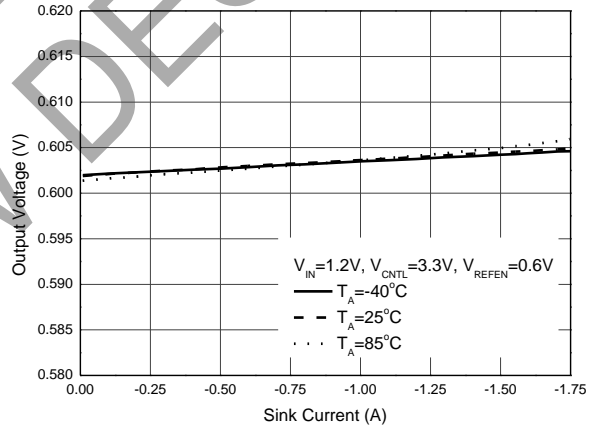

VIN Input Current vs. VIN Input Voltage

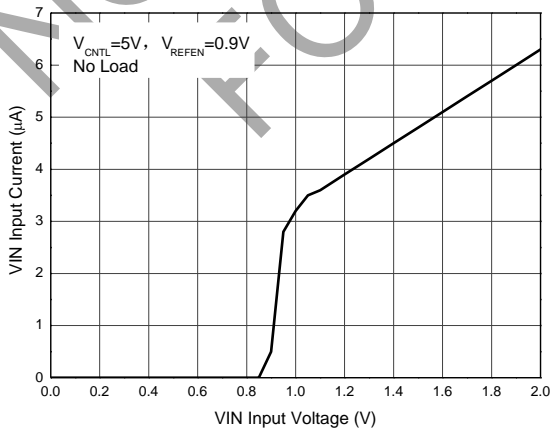

VIN Input Current vs. VCNTL Input Voltage

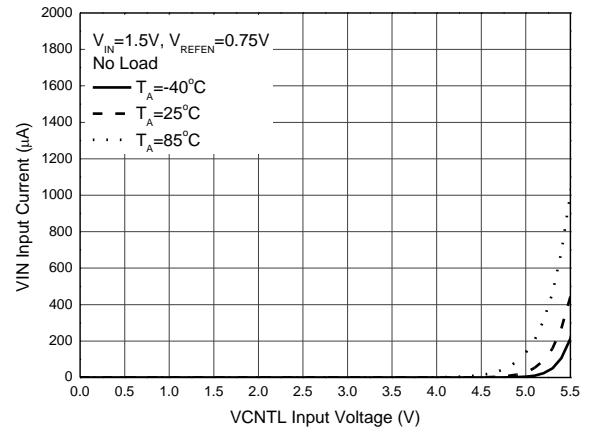

Performance Characteristics (continued)

Source Load Transient (DDR-III)
($C_{IN}=C_{OUT}=10\mu F$, $I_{OUT}=0A$ to $1.75A$,
 $V_{IN}=1.5V$, $V_{REFEN}=0.75V$, $V_{CNTL}=3.3V$)

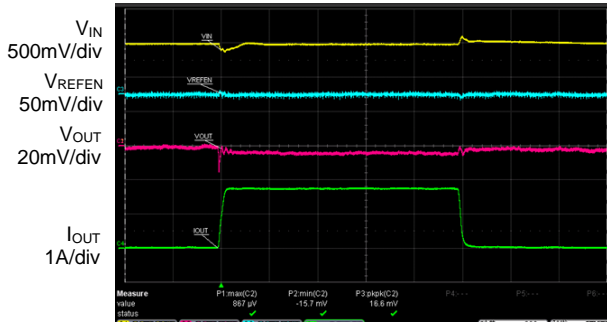

Time 100µs/div

Sink Load Transient (DDR-III)
($C_{IN}=C_{OUT}=10\mu F$, $I_{OUT}=0A$ to $-1.75A$,
 $V_{IN}=1.5V$, $V_{REFEN}=0.75V$, $V_{CNTL}=3.3V$)

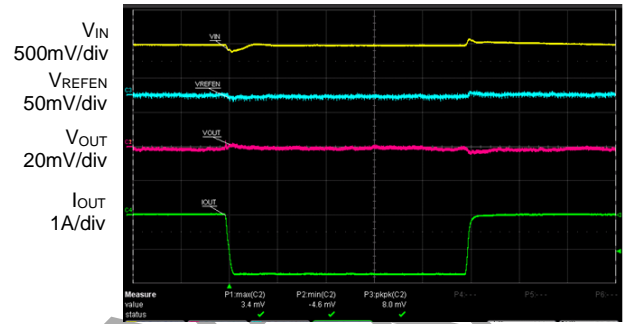

Time 100µs/div

Source Load Transient (DDR-IV)
($C_{IN}=C_{OUT}=10\mu F$, $I_{OUT}=0A$ to $1.75A$,
 $V_{IN}=1.2V$, $V_{REFEN}=0.6V$, $V_{CNTL}=3.3V$)

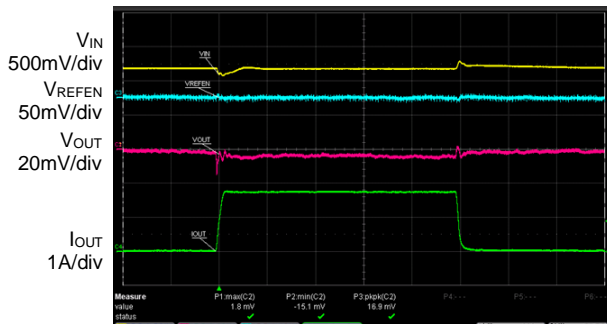

Time 100µs/div

Sink Load Transient (DDR-IV)
($C_{IN}=C_{OUT}=10\mu F$, $I_{OUT}=0A$ to $-1.75A$,
 $V_{IN}=1.2V$, $V_{REFEN}=0.6V$, $V_{CNTL}=3.3V$)

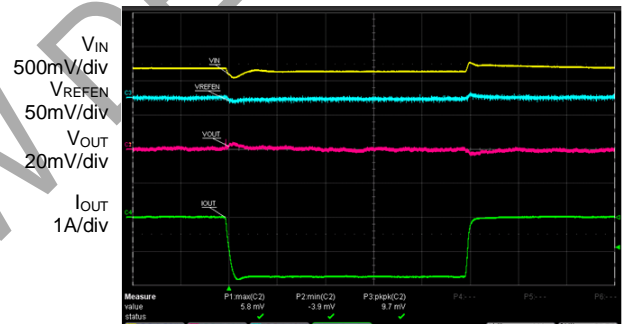

Time 100µs/div

VREFEN Power On
($C_{IN}=C_{OUT}=10\mu F$, $R_{LOAD}=5\Omega$, $V_{CNTL}=5V$)

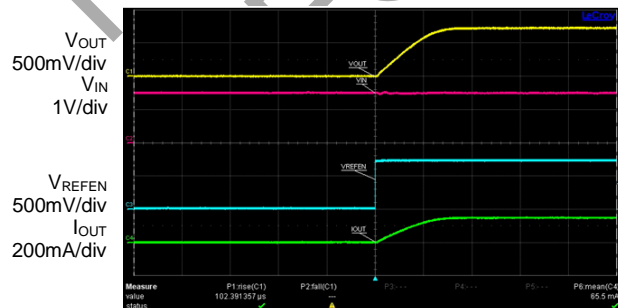

Time 100µs/div

VREFEN Power Off
($C_{IN}=C_{OUT}=10\mu F$, $R_{LOAD}=5\Omega$, $V_{CNTL}=5V$)

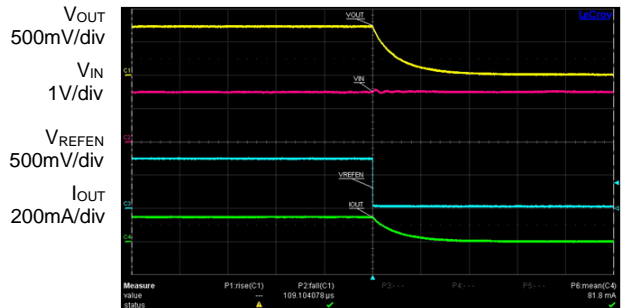

Time 100µs/div

Performance Characteristics (continued)

VIN Power On
($C_{IN}=C_{OUT}=10\mu F$, $R_{LOAD}=5\Omega$, $V_{CNTL}=5V$)

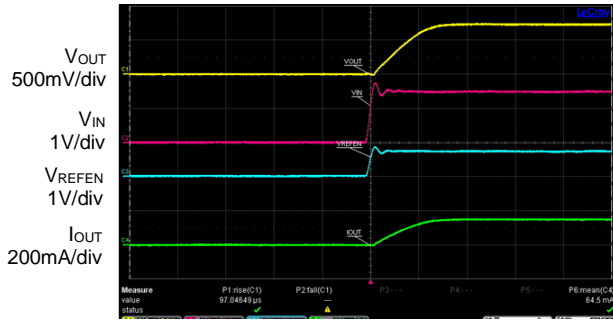

Time 100µs/div

VIN Power Off
($C_{IN}=C_{OUT}=10\mu F$, $R_{LOAD}=5\Omega$, $V_{CNTL}=5V$)

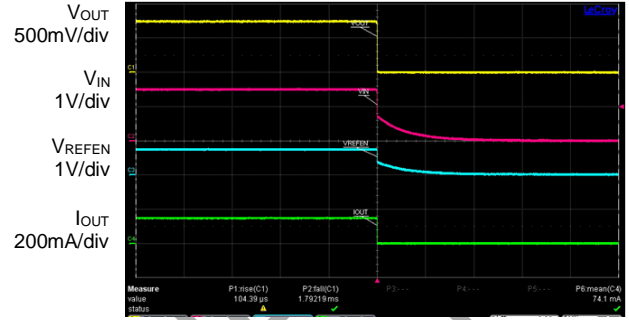

Time 500ms/div

VCNTL Power On
($C_{IN}=C_{OUT}=10\mu F$, $R_{LOAD}=5\Omega$)

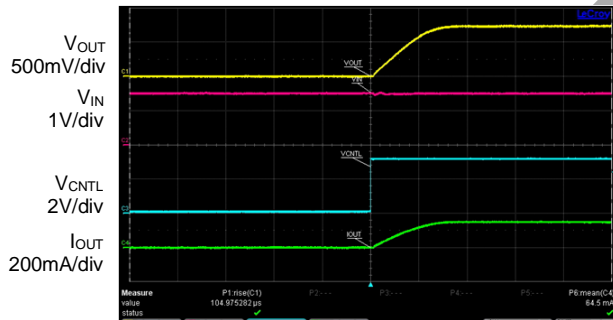

Time 100µs/div

VCNTL Power Off
($C_{IN}=C_{OUT}=10\mu F$, $R_{LOAD}=5\Omega$)

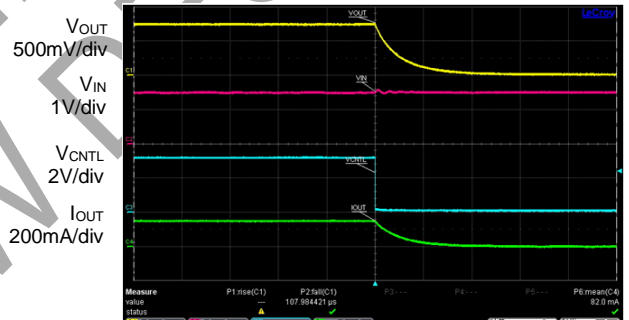

Time 100µs/div

NOT FOR NEW COMMERCIAL DESIGN

Applications

1. Input Capacitor

The input capacitor of VIN should be placed to VIN pin as close as possible. Use a low ESR, 10µF or larger MLCC capacitor to provide surge current during load transient.

The input capacitor for VCNTL is recommended to be 0.47µF or larger to decouple the supply voltage of the AP2303's control circuitry.

2. Output Capacitor

The output capacitor is recommended with a 10µF or higher MLCC capacitor which will be sufficient at full temperature range. An aluminum electrolytic capacitor with low ESR also should be larger than 10µF. The output capacitor should be placed to VOUT pin as close as possible.

3. Reference Voltage

A reference voltage is applied to the VREFEN pin by a resistor divider between VIN and GND pins. And a 0.1µF to 1µF bypass capacitor is preferred to form a low-pass filter to reduce the noise from VIN. More capacitance and large resistance will increase the start-up time after VIN power-up.

4. Thermal Consideration

There's an internal thermal protection circuitry of the AP2303 to protect device during overload conditions. For continuous operation, make sure not to exceed the operating junction temperature range of +125°C. The power dissipation definition in device is:

$$P_D = (V_{IN} - V_{OUT}) \times I_{OUT} + V_{IN} \times I_Q$$

The maximum power dissipation depends on the thermal resistance of IC package, PCB layout and the surrounding airflow. The maximum power dissipation can also be calculated as:

$$P_{D(MAX)} = (T_{J(MAX)} - T_A) / \theta_{JA}$$

The maximum power dissipation for PSOP-8 package at $T_A = +25^\circ\text{C}$ can be calculated as:

$$P_{D(MAX)} = (125^\circ\text{C} - 25^\circ\text{C}) / (80^\circ\text{C}/\text{W}) = 1.25\text{W}$$

Ordering Information

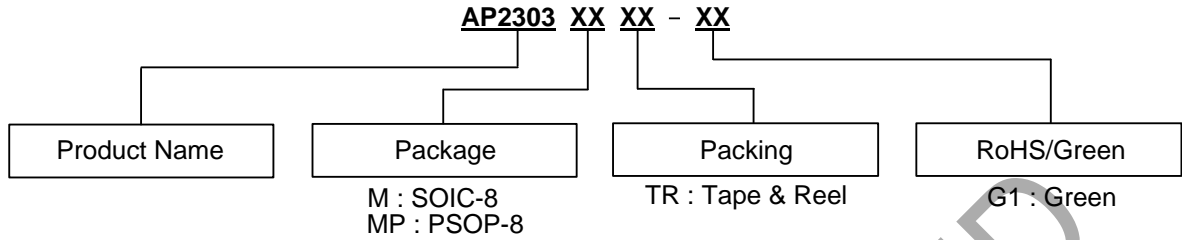

Diodes IC's Pb-free products with "G1" suffix in the part number, are RoHS compliant and green.

Part Number	Package	Temperature Range	Marking ID	Packing	
				Qty.	Carrier
AP2303MTR-G1	SOIC-8	-40°C to +85°C	2303M-G1	4000	Tape & Reel
AP2303MPTR-G1	PSOP-8		2303MP-G1	4000	Tape & Reel

Marking Information

(1) SOIC-8

(Top View)

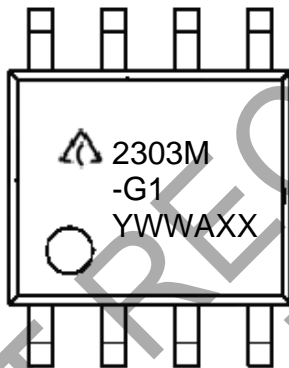

First and Second Lines: Logo and Marking ID
 Third Line: Date Code
 Y: Year
 WW: Work Week of Molding
 A: Assembly House Code
 XX: 7th and 8th Digits of Batch No.

(2) PSOP-8

(Top View)

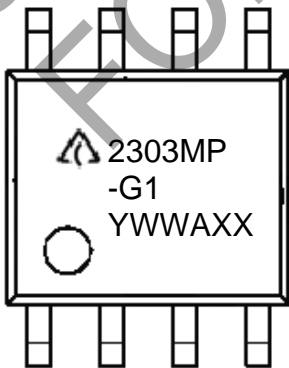

First and Second Lines: Logo and Marking ID
 Third Line: Date Code
 Y: Year
 WW: Work Week of Molding
 A: Assembly House Code
 XX: 7th and 8th Digits of Batch No.

Package Outline Dimensions (continued. All dimensions in mm(inch).)

Please see <http://www.diodes.com/package-outlines.html> for the latest version.

(2) Package Type: PSOP-8

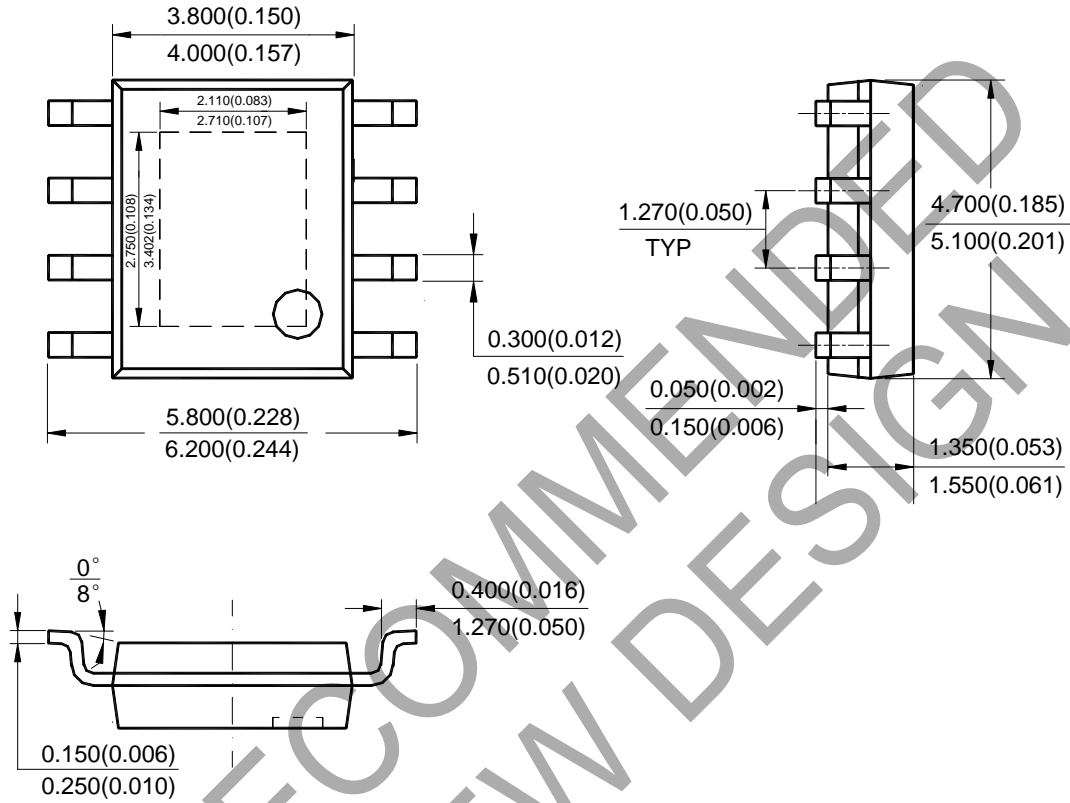

Note: Eject hole, oriented hole and mold mark is optional.

NOT RECOMMENDED FOR NEW DESIGN

Suggested Pad Layout

Please see <http://www.diodes.com/package-outlines.html> for the latest version.

(1) Package Type: SOIC-8

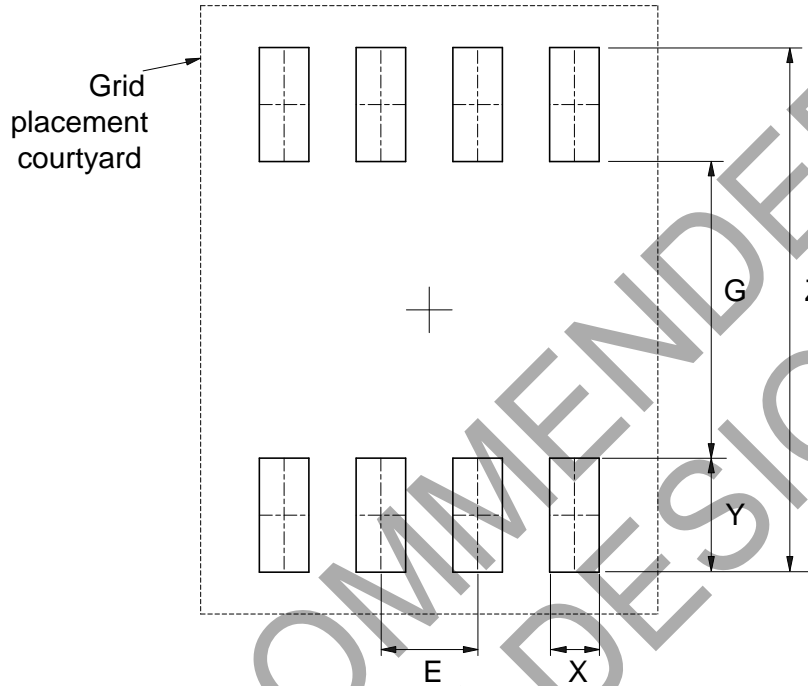

Dimensions	Z (mm)/(inch)	G (mm)/(inch)	X (mm)/(inch)	Y (mm)/(inch)	E (mm)/(inch)
Value	6.900/0.272	3.900/0.154	0.650/0.026	1.500/0.059	1.270/0.050

NOT RECOMMENDED FOR NEW DESIGN

Suggested Pad Layout (continued)

Please see <http://www.diodes.com/package-outlines.html> for the latest version.

(2) Package Type: PSOP-8

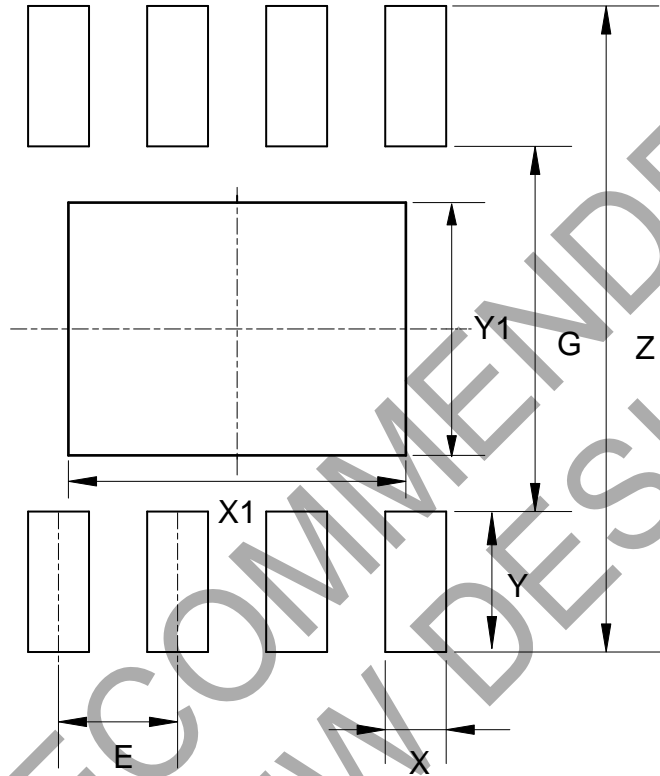

Dimensions	Z (mm)/(inch)	G (mm)/(inch)	X (mm)/(inch)	Y (mm)/(inch)	X1 (mm)/(inch)	Y1 (mm)/(inch)	E (mm)/(inch)
Value	6.900/0.272	3.900/0.154	0.650/0.026	1.500/0.059	3.600/0.142	2.700/0.106	1.270/0.050

IMPORTANT NOTICE

1. DIODES INCORPORATED (Diodes) AND ITS SUBSIDIARIES MAKE NO WARRANTY OF ANY KIND, EXPRESS OR IMPLIED, WITH REGARDS TO ANY INFORMATION CONTAINED IN THIS DOCUMENT, INCLUDING, BUT NOT LIMITED TO, THE IMPLIED WARRANTIES OF MERCHANTABILITY, FITNESS FOR A PARTICULAR PURPOSE OR NON-INFRINGEMENT OF THIRD PARTY INTELLECTUAL PROPERTY RIGHTS (AND THEIR EQUIVALENTS UNDER THE LAWS OF ANY JURISDICTION).
2. The Information contained herein is for informational purpose only and is provided only to illustrate the operation of Diodes' products described herein and application examples. Diodes does not assume any liability arising out of the application or use of this document or any product described herein. This document is intended for skilled and technically trained engineering customers and users who design with Diodes' products. Diodes' products may be used to facilitate safety-related applications; however, in all instances customers and users are responsible for (a) selecting the appropriate Diodes products for their applications, (b) evaluating the suitability of Diodes' products for their intended applications, (c) ensuring their applications, which incorporate Diodes' products, comply the applicable legal and regulatory requirements as well as safety and functional-safety related standards, and (d) ensuring they design with appropriate safeguards (including testing, validation, quality control techniques, redundancy, malfunction prevention, and appropriate treatment for aging degradation) to minimize the risks associated with their applications.
3. Diodes assumes no liability for any application-related information, support, assistance or feedback that may be provided by Diodes from time to time. Any customer or user of this document or products described herein will assume all risks and liabilities associated with such use, and will hold Diodes and all companies whose products are represented herein or on Diodes' websites, harmless against all damages and liabilities.
4. Products described herein may be covered by one or more United States, international or foreign patents and pending patent applications. Product names and markings noted herein may also be covered by one or more United States, international or foreign trademarks and trademark applications. Diodes does not convey any license under any of its intellectual property rights or the rights of any third parties (including third parties whose products and services may be described in this document or on Diodes' website) under this document.
5. Diodes' products are provided subject to Diodes' Standard Terms and Conditions of Sale (<https://www.diodes.com/about/company/terms-and-conditions/terms-and-conditions-of-sales/>) or other applicable terms. This document does not alter or expand the applicable warranties provided by Diodes. Diodes does not warrant or accept any liability whatsoever in respect of any products purchased through unauthorized sales channel.
6. Diodes' products and technology may not be used for or incorporated into any products or systems whose manufacture, use or sale is prohibited under any applicable laws and regulations. Should customers or users use Diodes' products in contravention of any applicable laws or regulations, or for any unintended or unauthorized application, customers and users will (a) be solely responsible for any damages, losses or penalties arising in connection therewith or as a result thereof, and (b) indemnify and hold Diodes and its representatives and agents harmless against any and all claims, damages, expenses, and attorney fees arising out of, directly or indirectly, any claim relating to any noncompliance with the applicable laws and regulations, as well as any unintended or unauthorized application.
7. While efforts have been made to ensure the information contained in this document is accurate, complete and current, it may contain technical inaccuracies, omissions and typographical errors. Diodes does not warrant that information contained in this document is error-free and Diodes is under no obligation to update or otherwise correct this information. Notwithstanding the foregoing, Diodes reserves the right to make modifications, enhancements, improvements, corrections or other changes without further notice to this document and any product described herein. This document is written in English but may be translated into multiple languages for reference. Only the English version of this document is the final and determinative format released by Diodes.
8. Any unauthorized copying, modification, distribution, transmission, display or other use of this document (or any portion hereof) is prohibited. Diodes assumes no responsibility for any losses incurred by the customers or users or any third parties arising from any such unauthorized use.
9. This Notice may be periodically updated with the most recent version available at <https://www.diodes.com/about/company/terms-and-conditions/important-notice>

The Diodes logo is a registered trademark of Diodes Incorporated in the United States and other countries.
All other trademarks are the property of their respective owners.
© 2024 Diodes Incorporated. All Rights Reserved.

www.diodes.com